

3D Data Structure Development

Chris Gold
Pawel Boguslawski

U Glamorgan, Wales



History

- Adaptive surface data structures (TINs)
- Edge algebras (QEs)
- Dynamic map history management (Mioc)
- 2D Kinetic Voronoi (Anton, Yang, Mostafavi, Dakowicz)
- Importance of the dual and skeleton (Thibault)
- CAD: B-Rep Euler Operators from QE (Tse)
- 3D kinetic Voronoi (Ledoux)
- 3D volumetric models (AQE) (Ledoux)
- Voronoi hierarchies
- AQE "Euler Operators" (Boguslawski)

Quad-Edge Structure

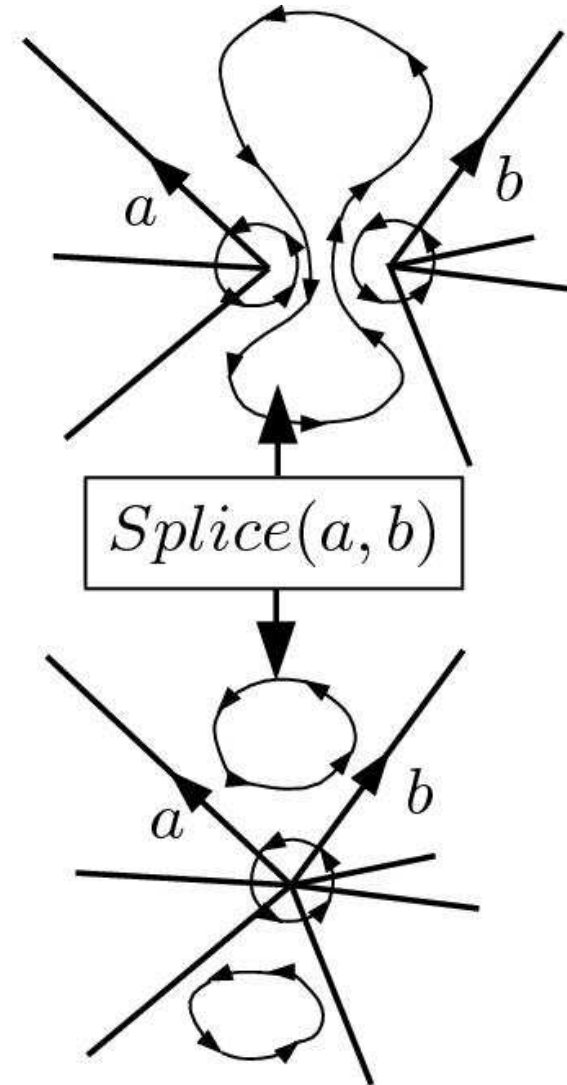
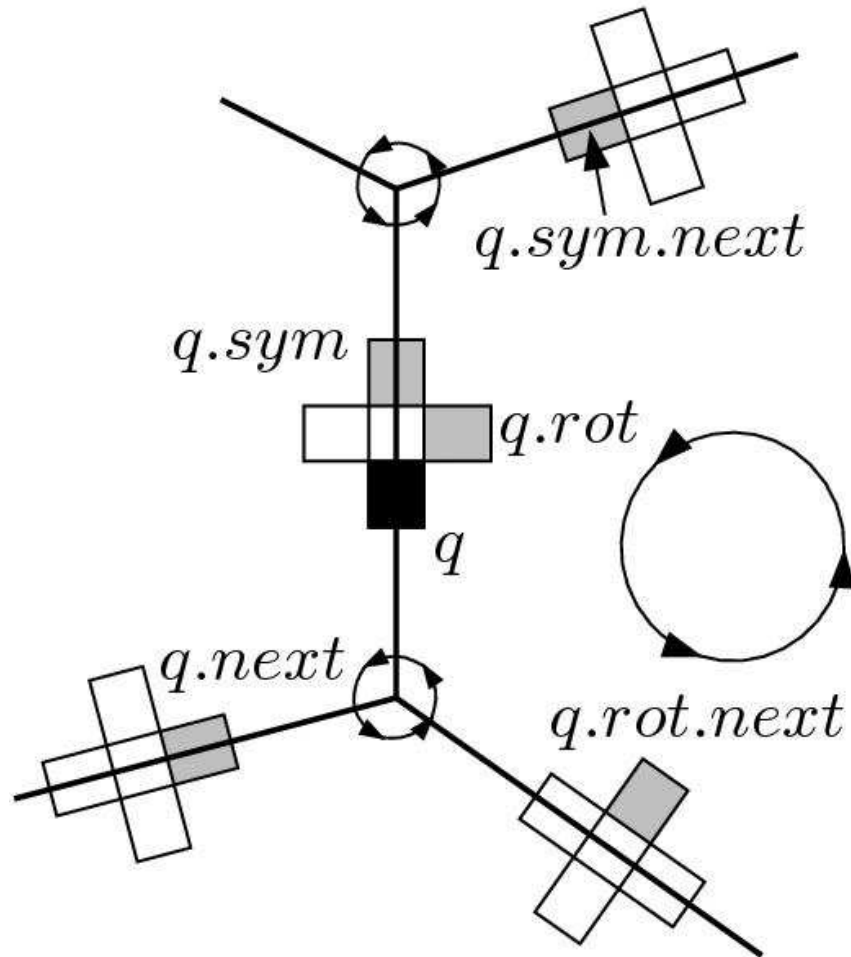

Building boundaries

a) triangles b) Voronoi cells
- built with kinetic DT/VD

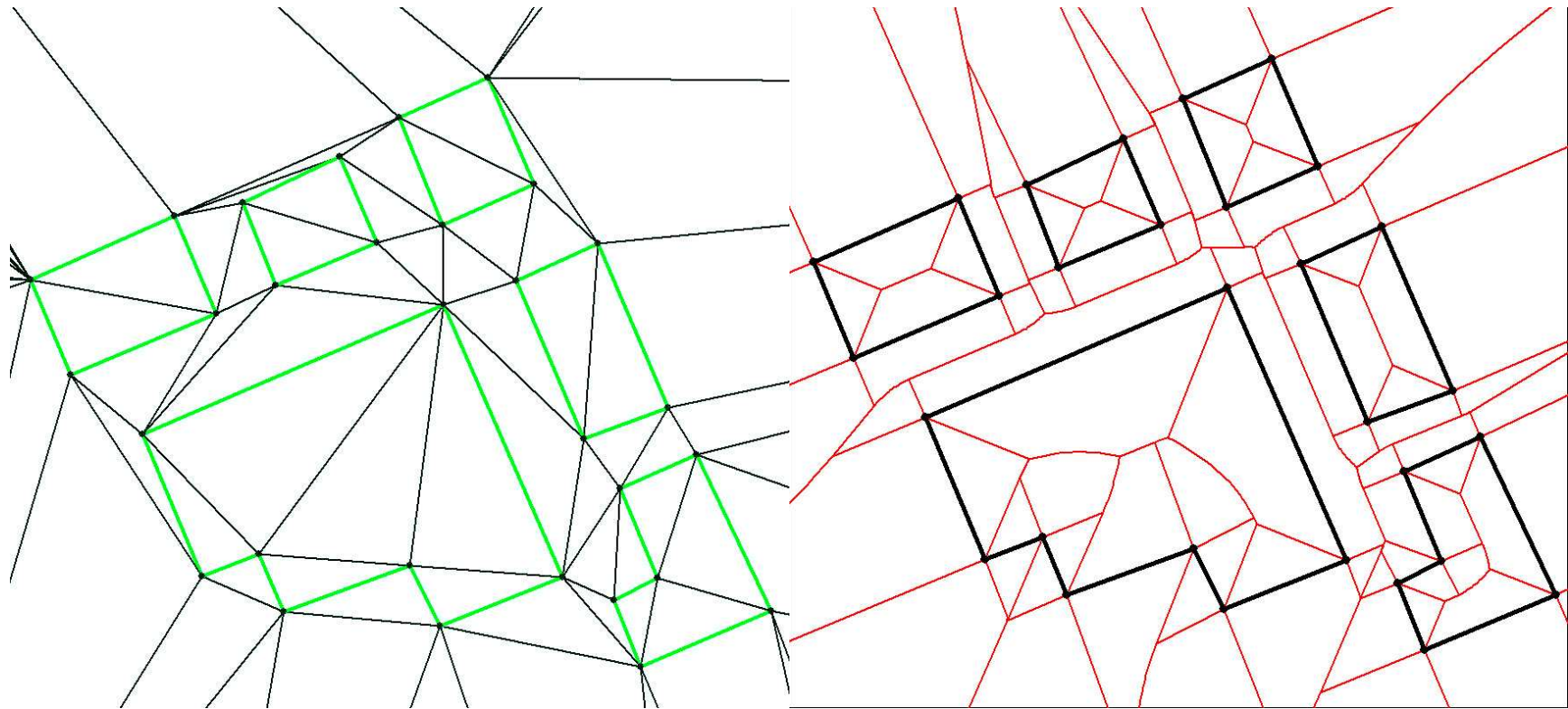

Compound Cells + Adjacency

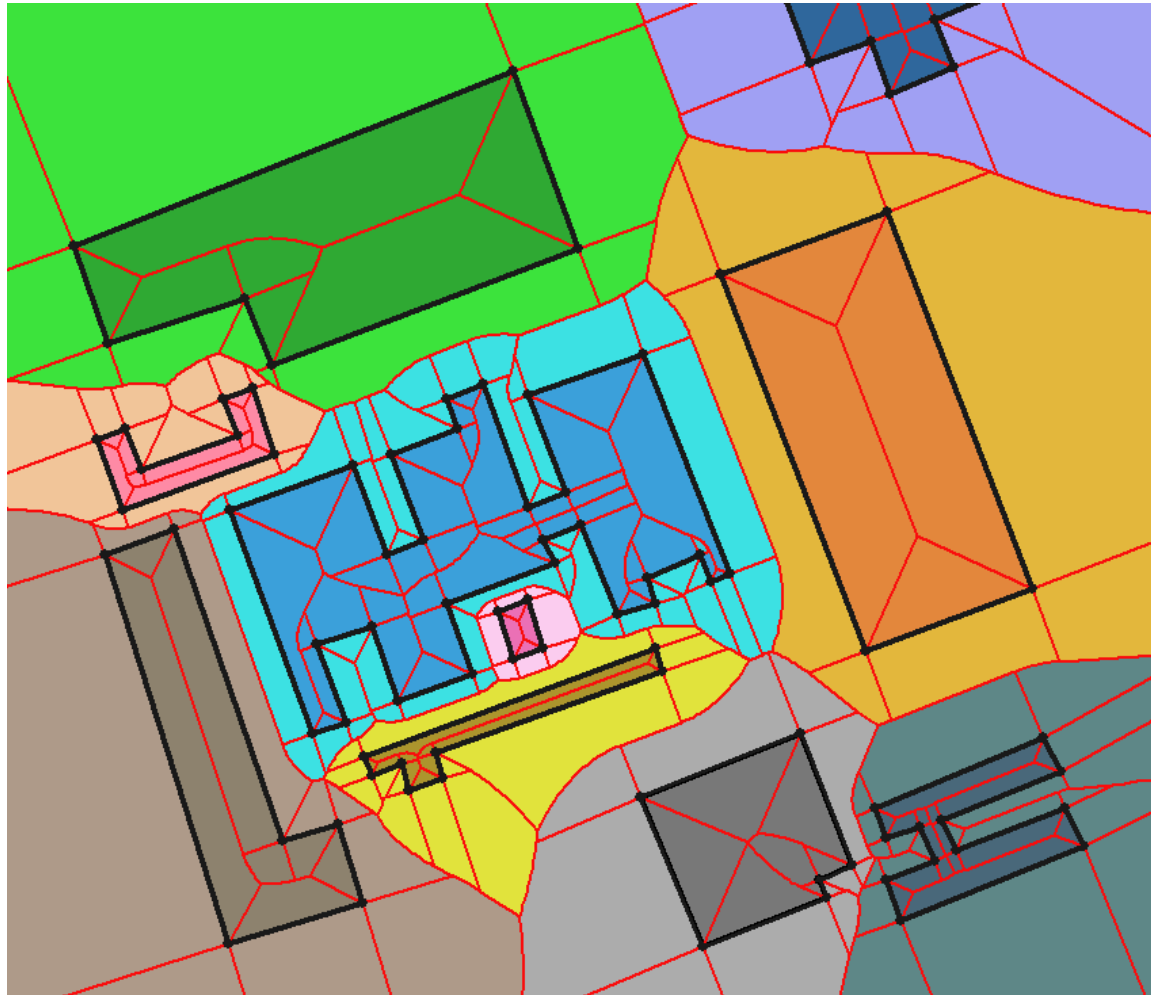

Euler Operators from QE

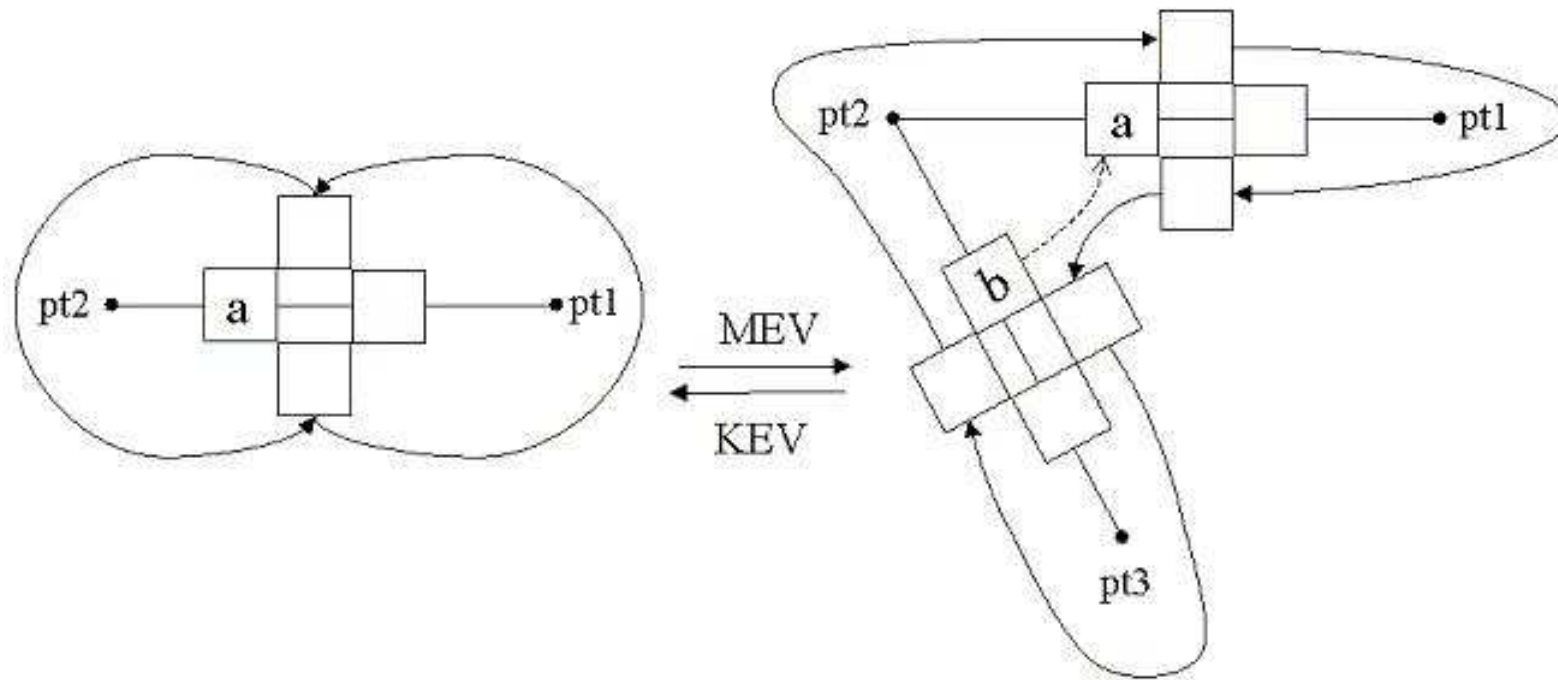

Building Extrusion from E-Os

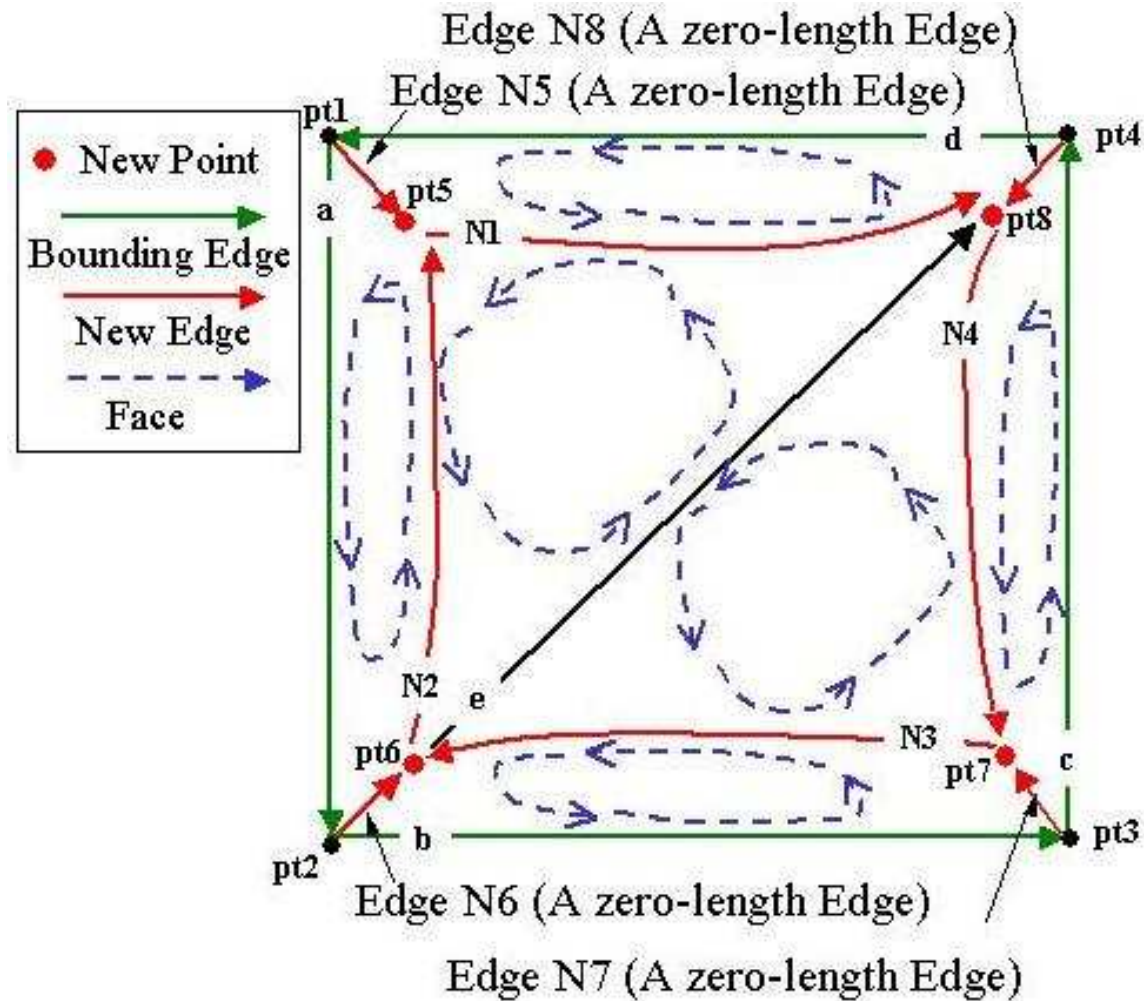

Bridge or Hole from E-Os

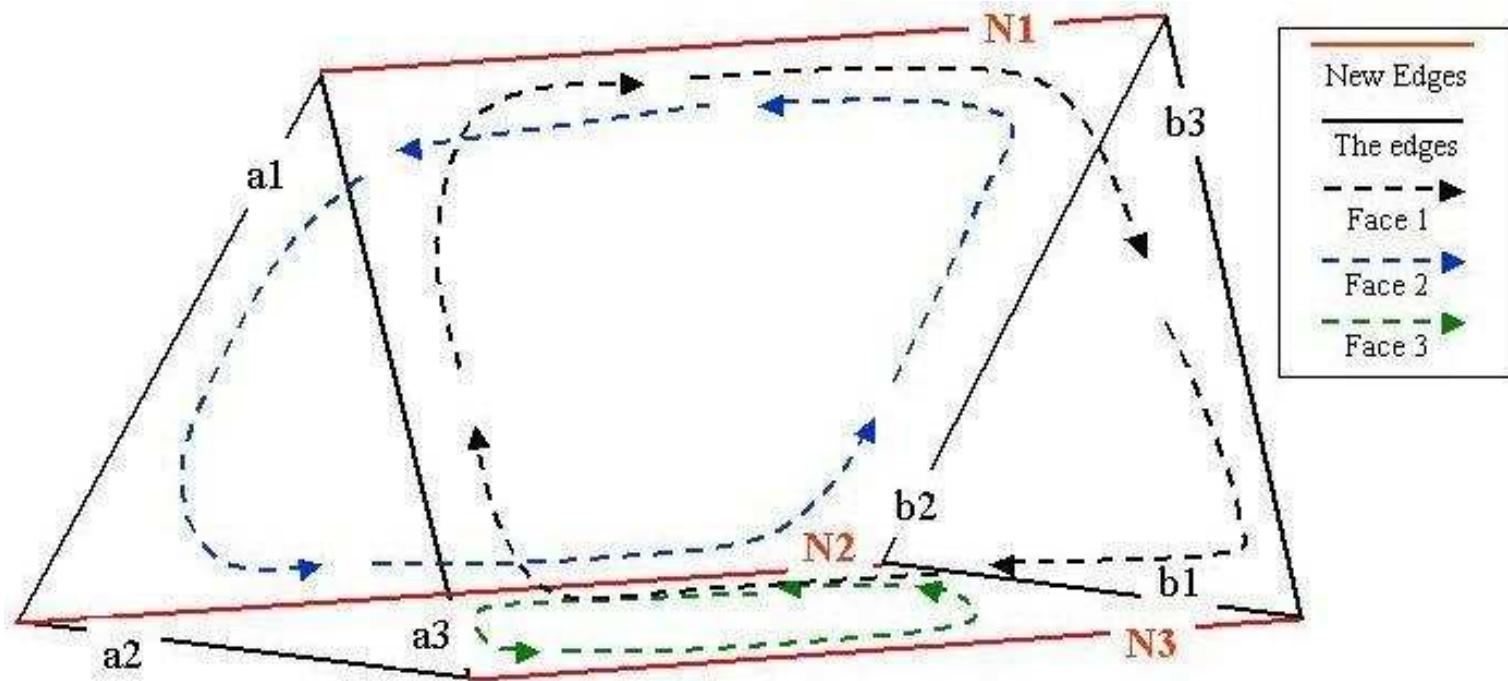

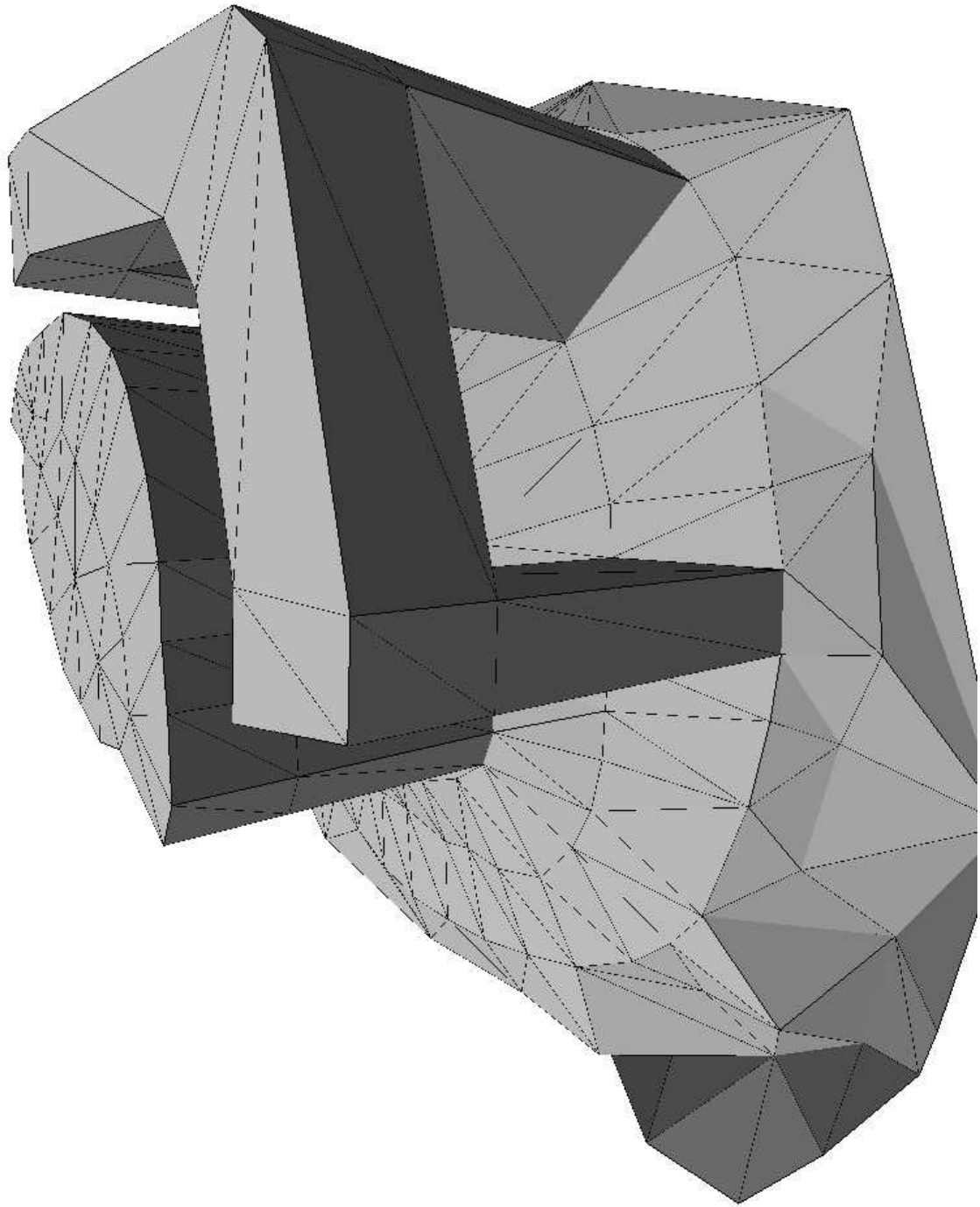

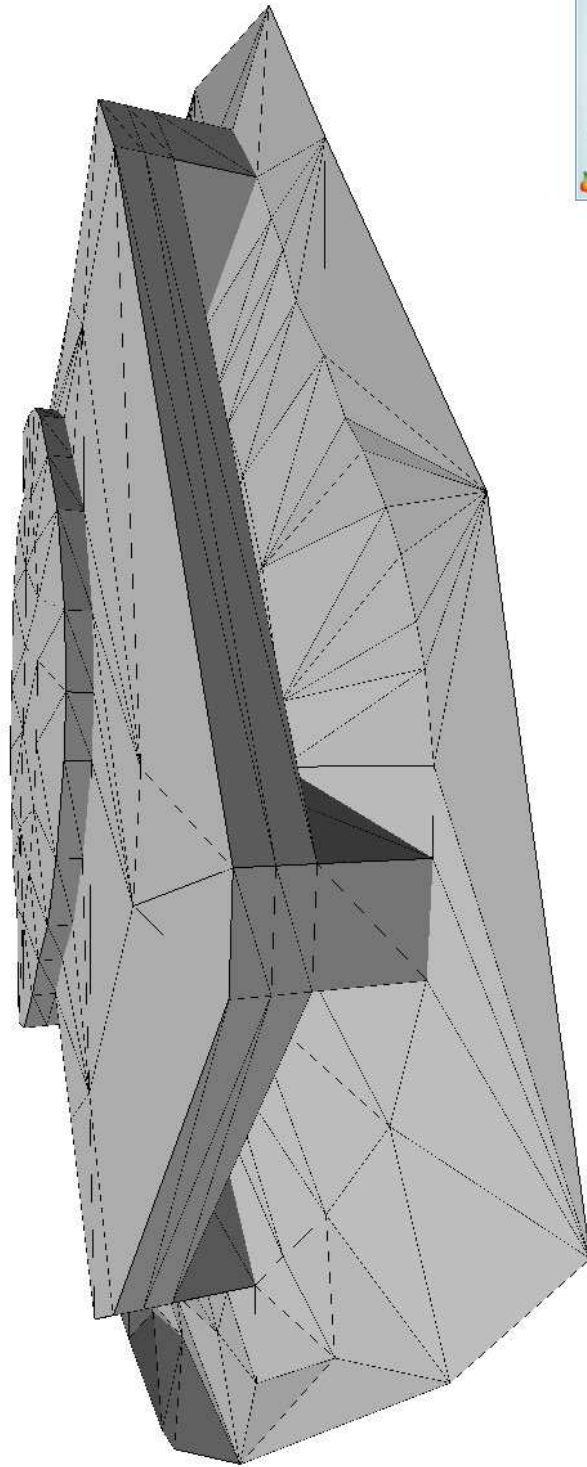

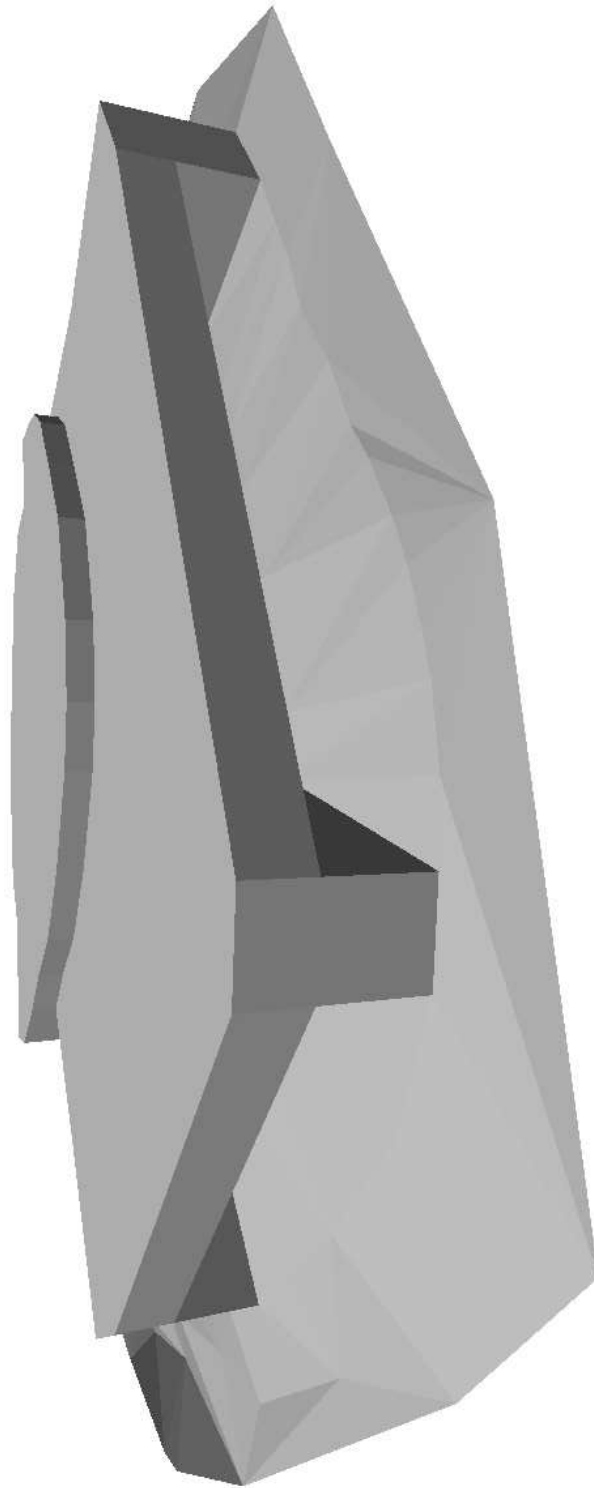

Voronoi Indexing: Christaller hierarchies

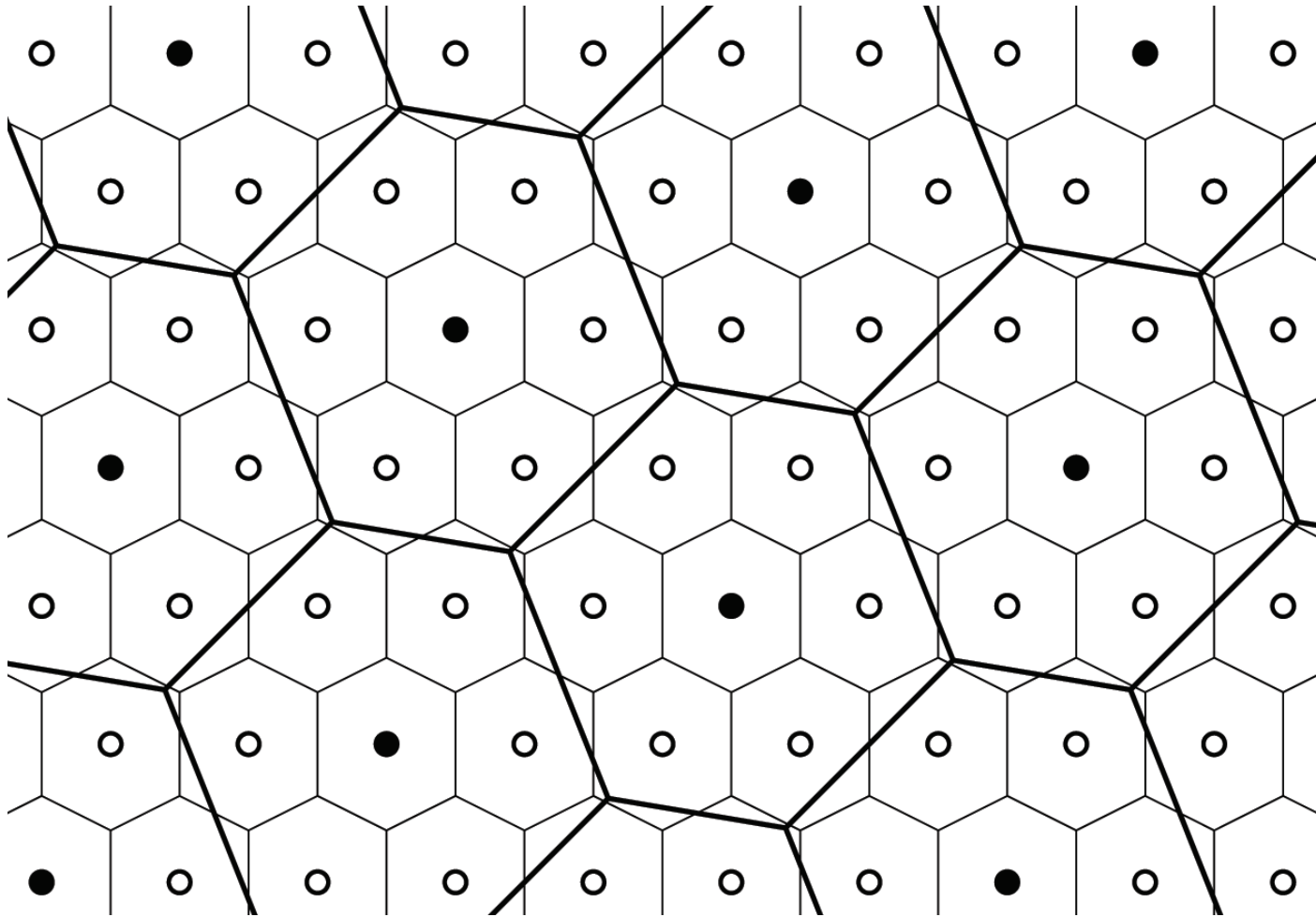

Three-level Voronoi hierarchy

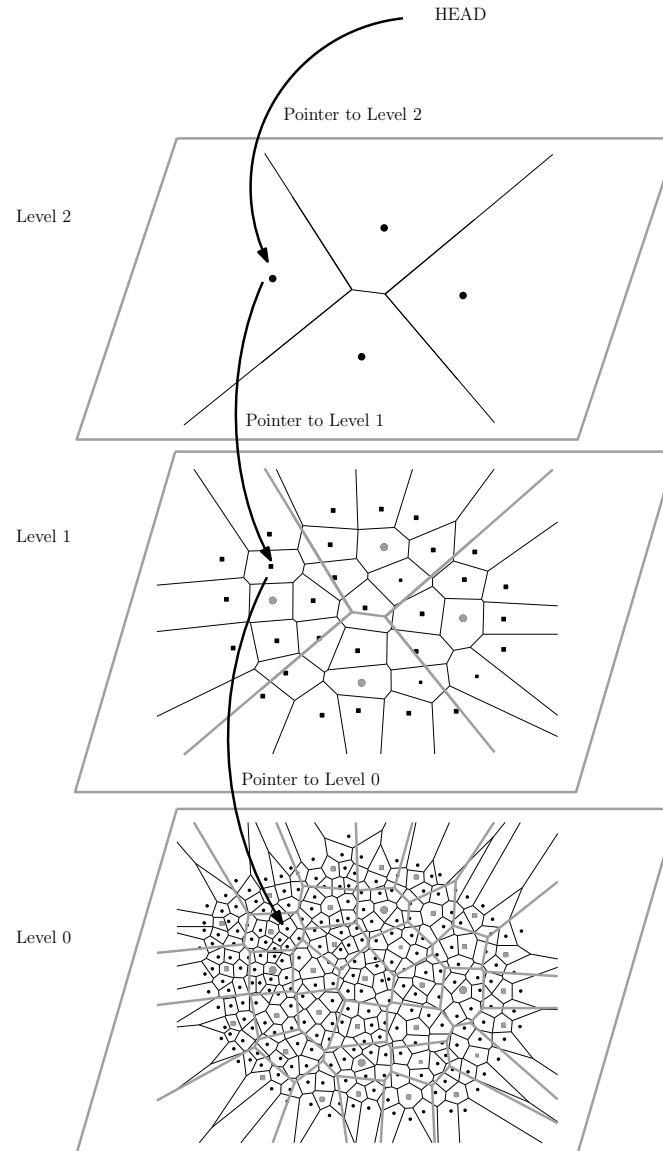

Paging to Disc

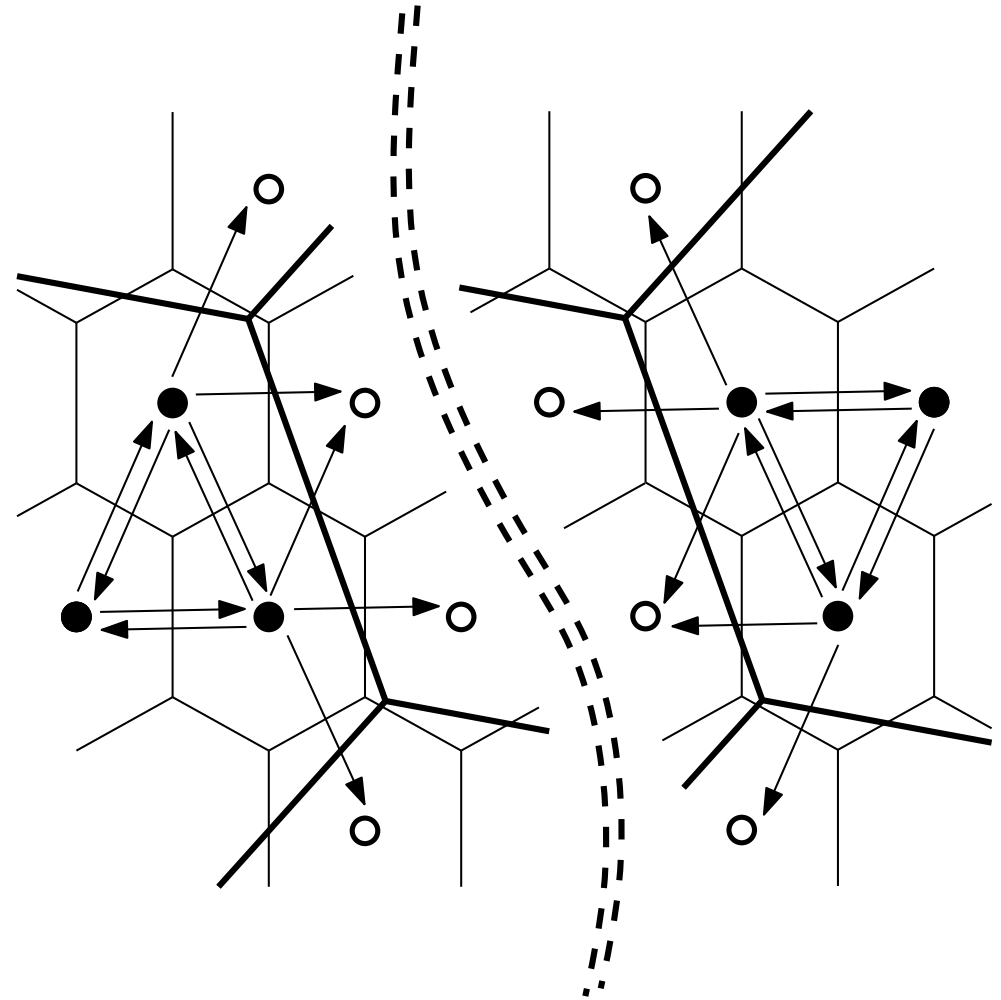
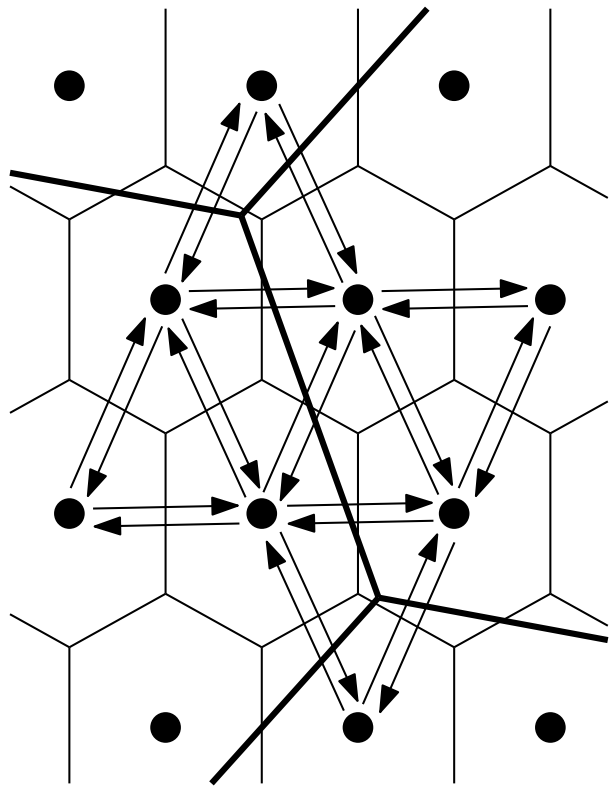

Full 3D Structures

- The principles of planar graphs in 2D can be extended to volumetric graphs in 3D, with the addition of 3D volumes or “bubbles”.
- Volumes are dual to nodes, and edges are dual to faces.
- We need to model solids, not just surfaces

Delaunay Tetrahedron/Voronoi Cell

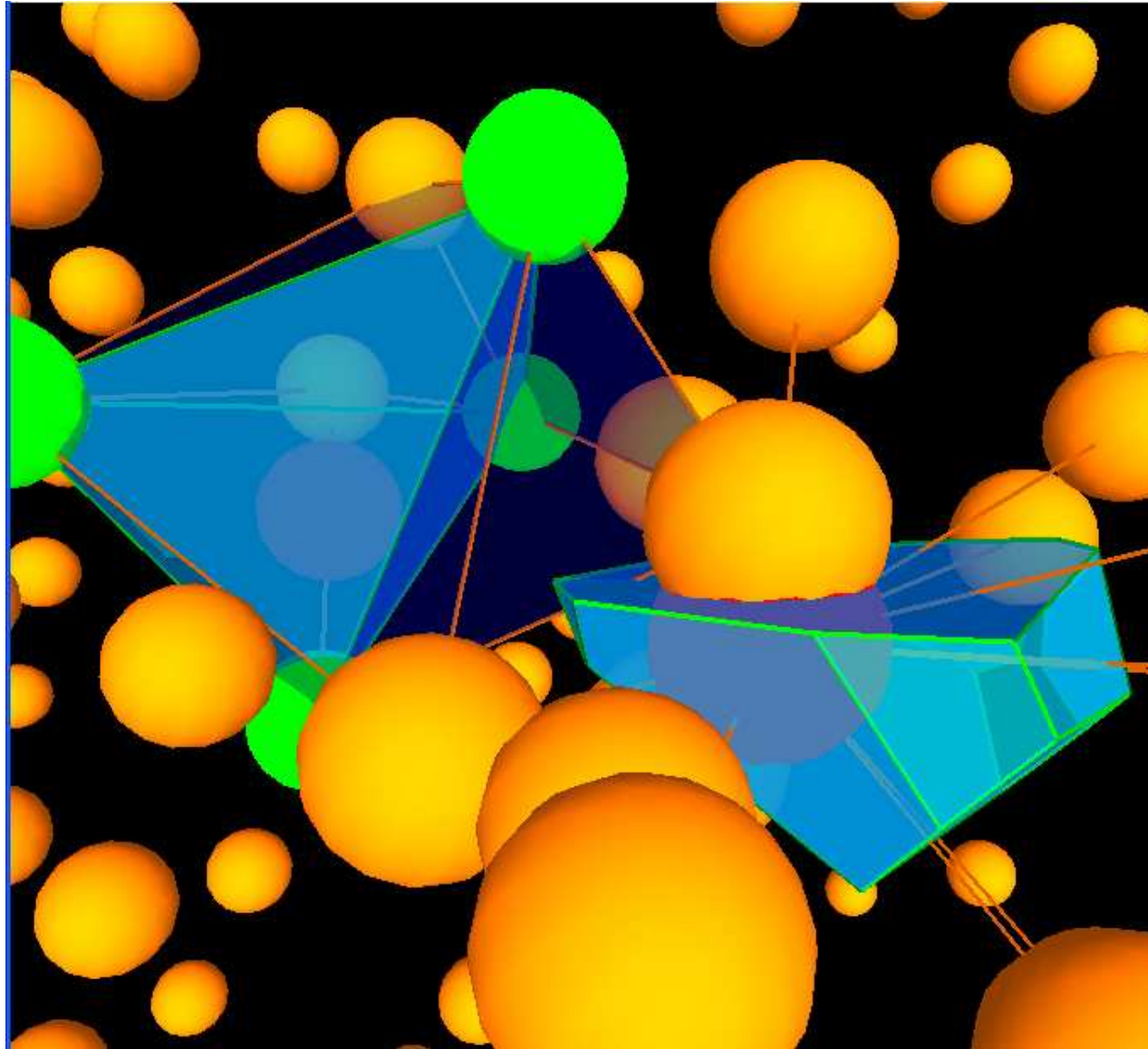

Extruded Buildings

- just a surface model (B-Rep)

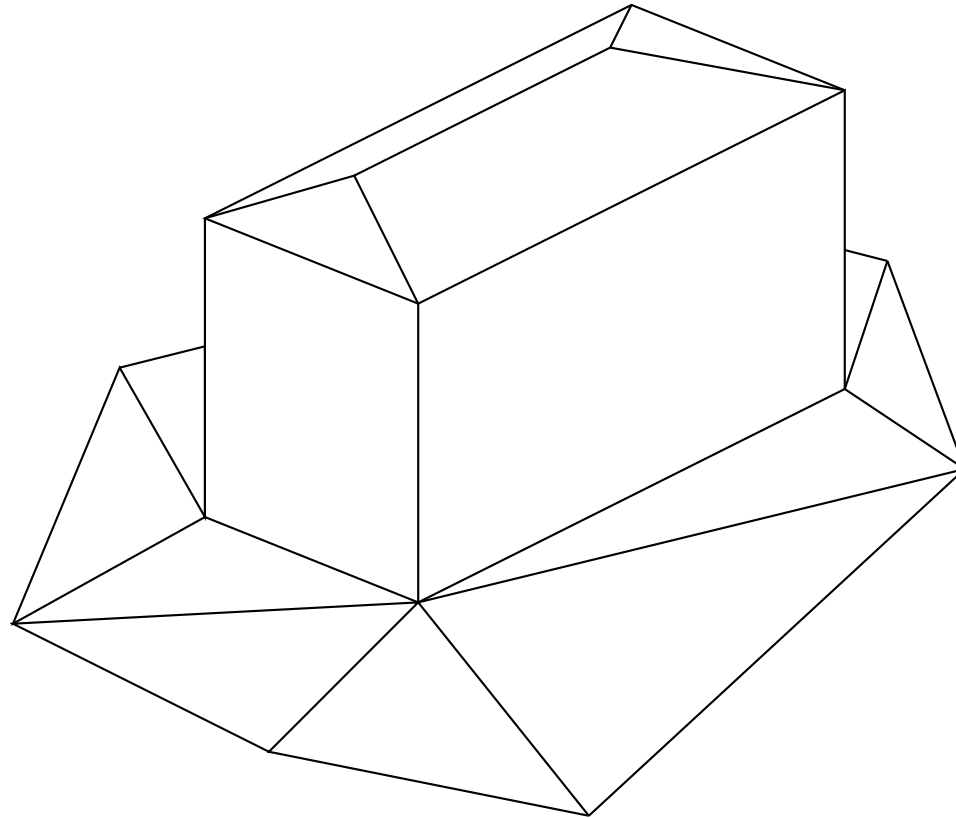

True 3D Structures

- dual links across the surface

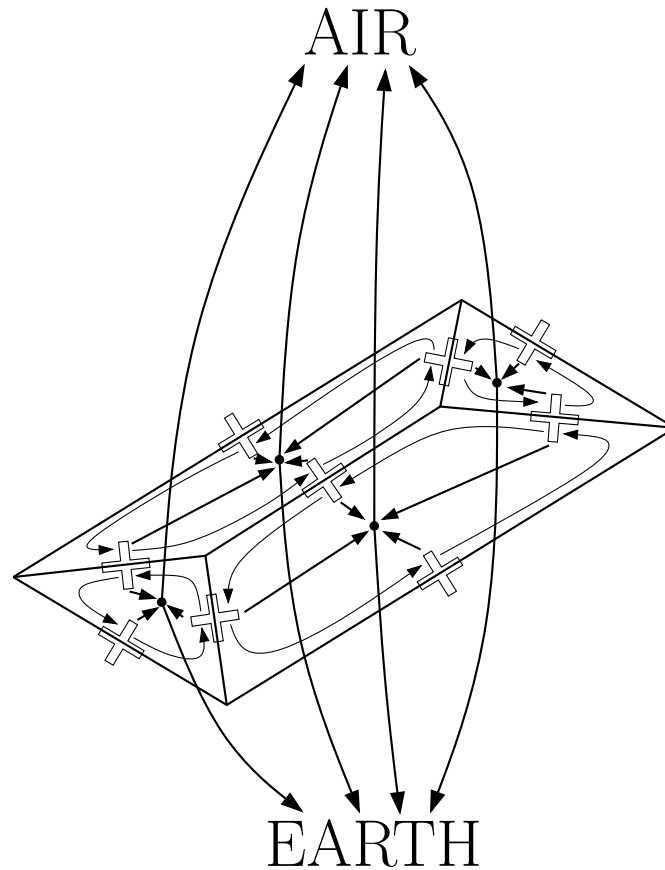

Full 3D Structures

- interior volumes are included

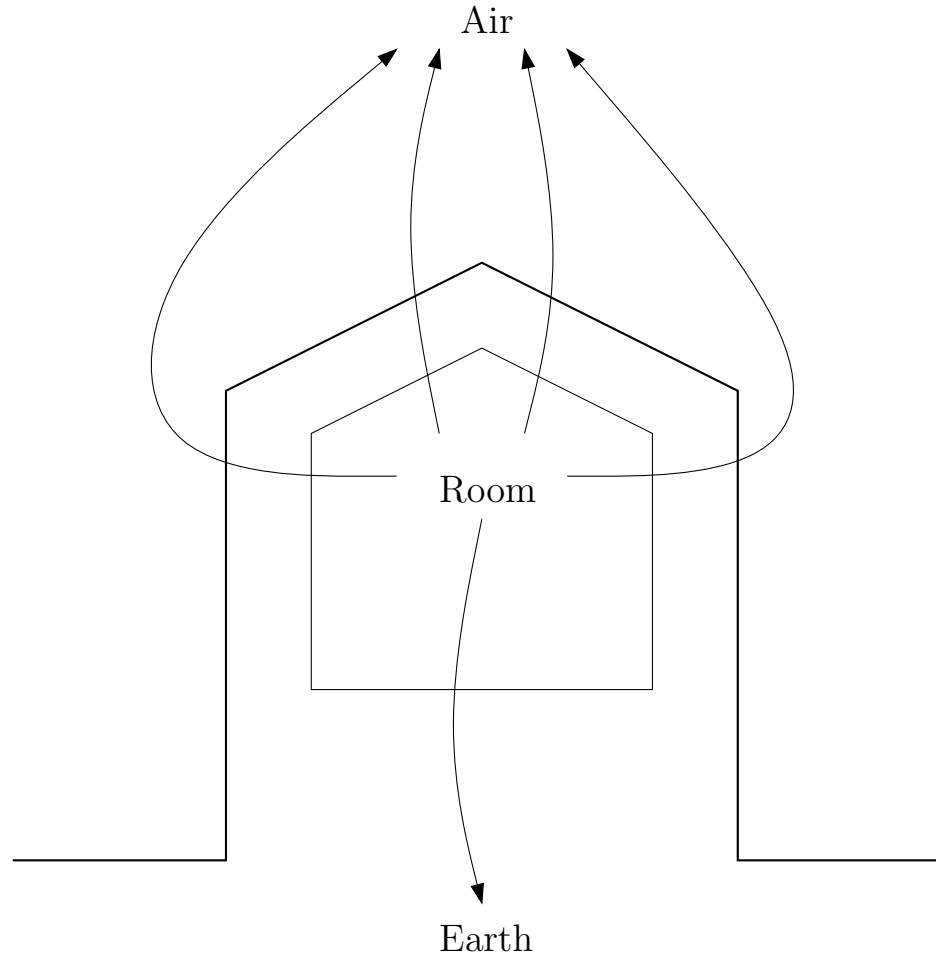

3D Navigation

- For many 3D urban applications we need to be able to navigate between rooms, etc.
- Our “Augmented Quad-Edge” structure makes this possible.
- Basically, it combines the surface model with the dual, penetrating edges.
- We can then navigate the graph between rooms, walls, etc.

Navigation of Rooms and Walls

- starting from q_f we can find adjacent features

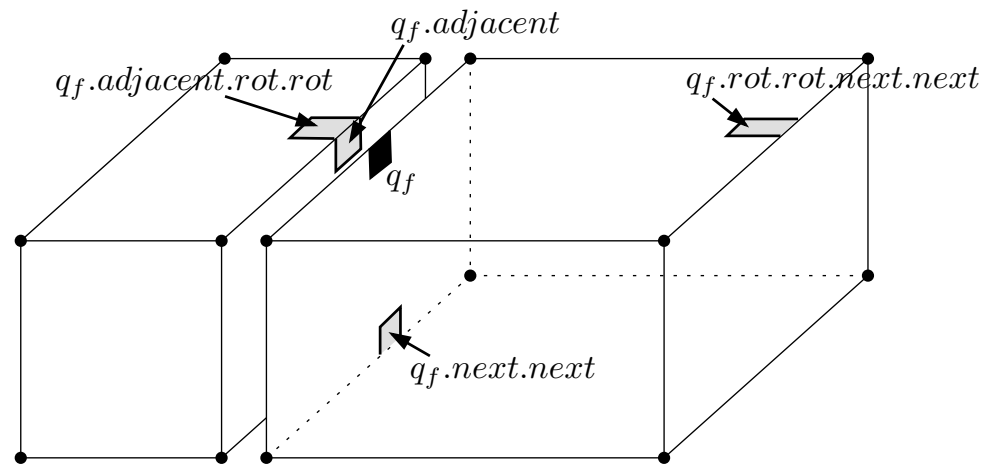
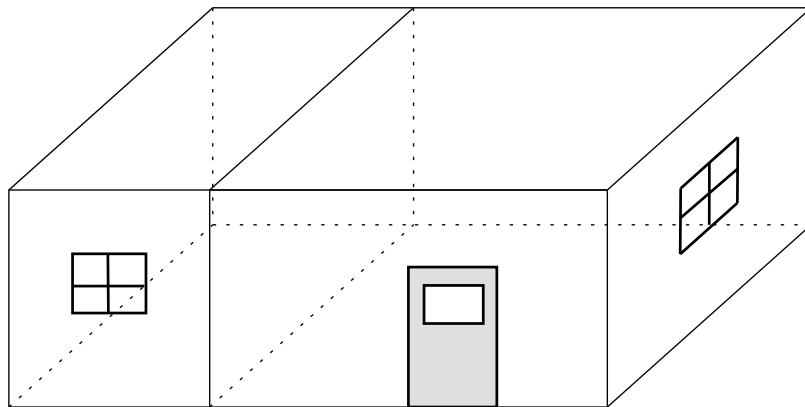

3D Object Reconstruction

- We need to build our graph before we can use it.
- Individual pieces must be snapped together like “Lego”.
- This is related to the “Euler Operators” used in CAD systems for surface models
- Using Half-AQE elements we can derive atomic construction elements

Make Half-AQE

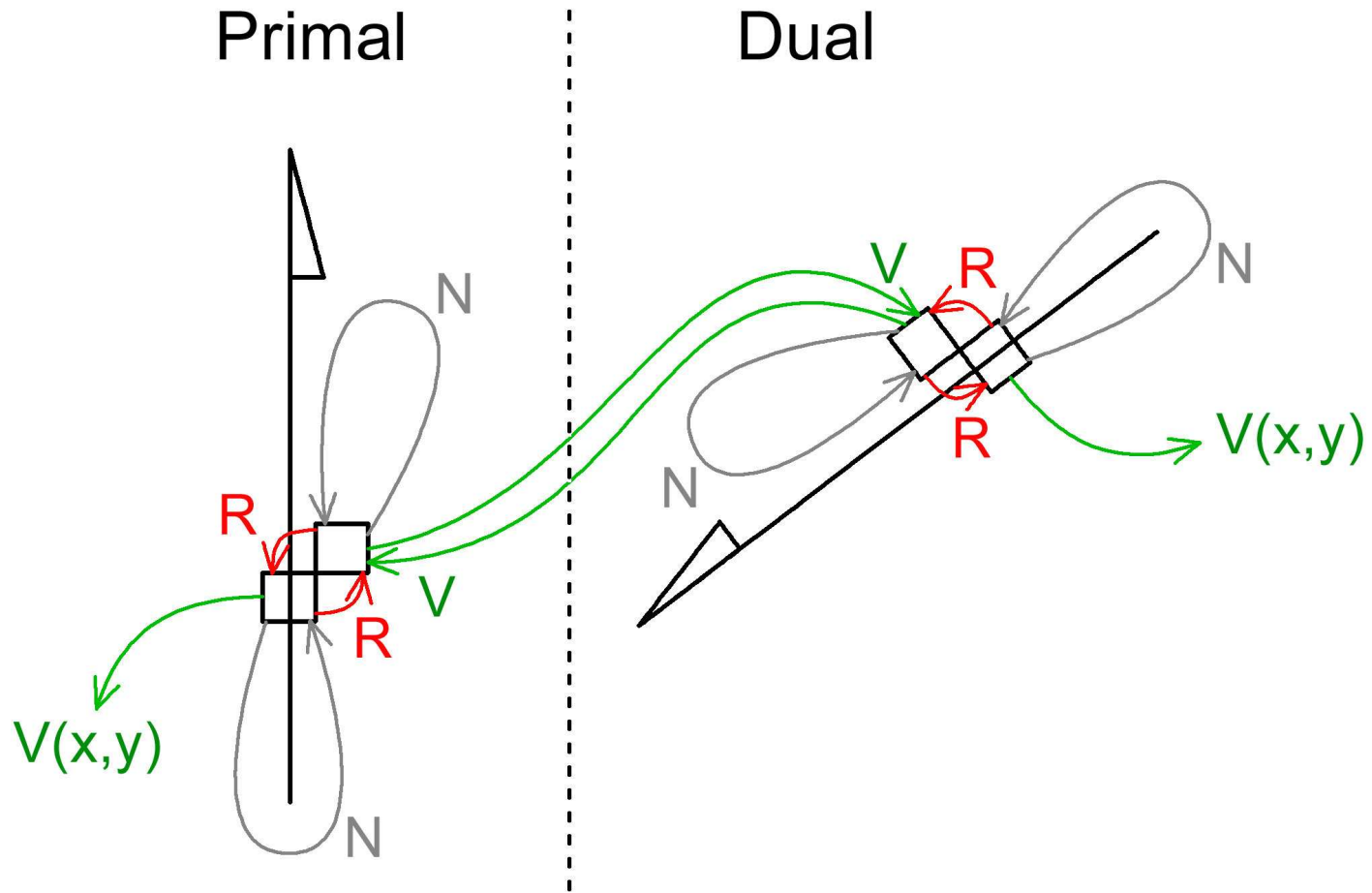

Connect Half-AQE

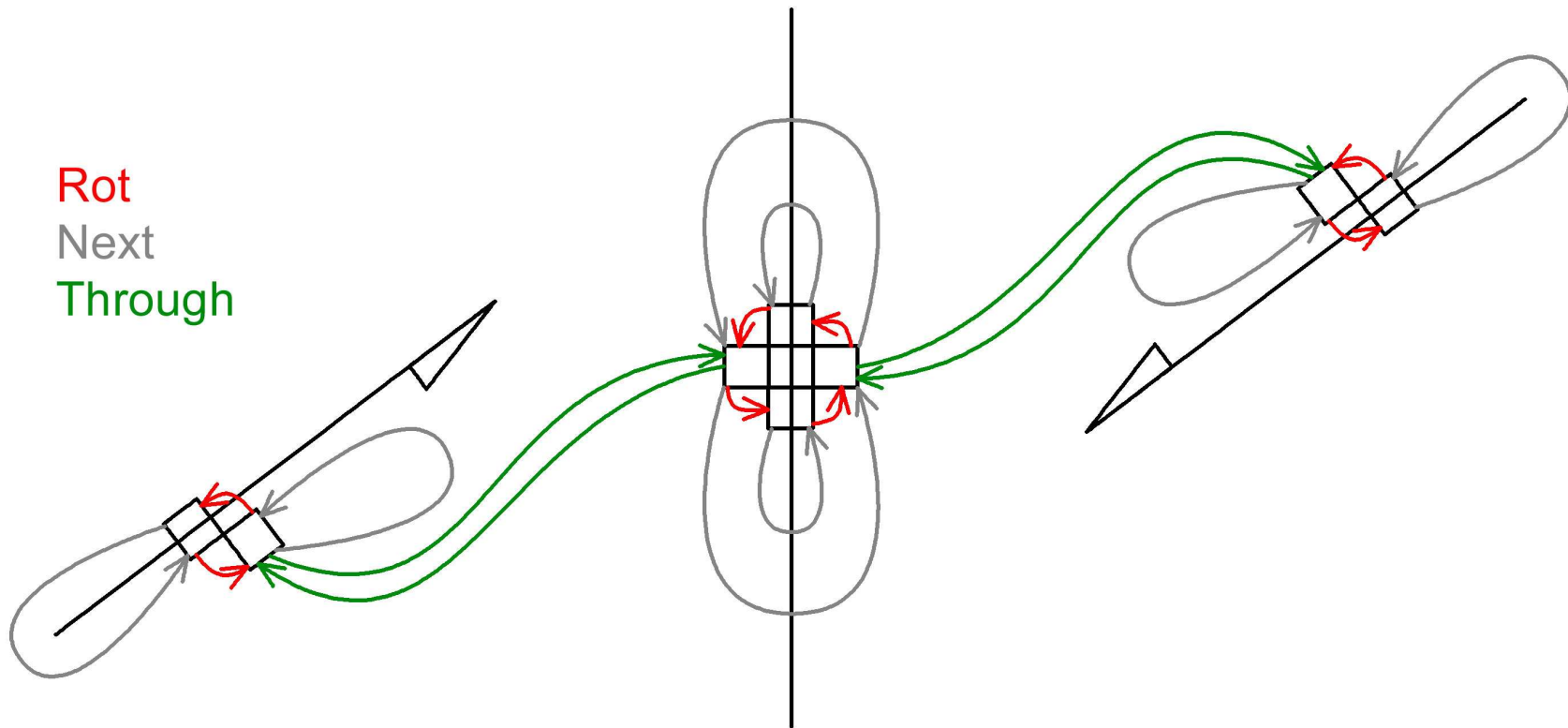

Make Face

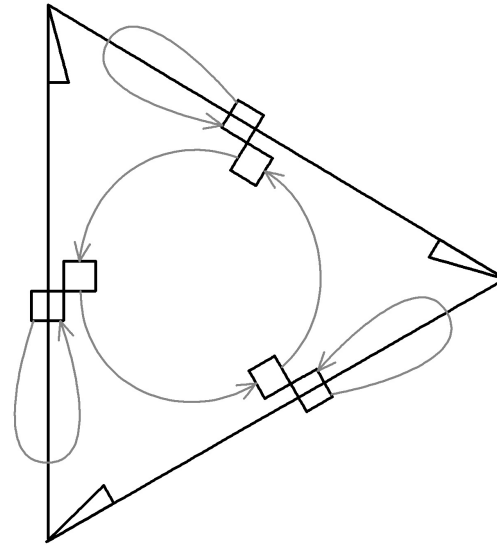
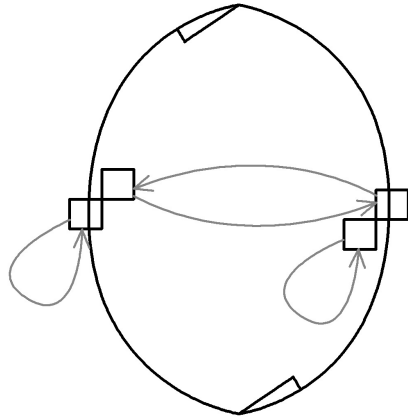
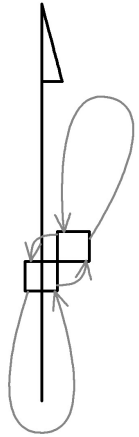

Connect Neighbour Faces

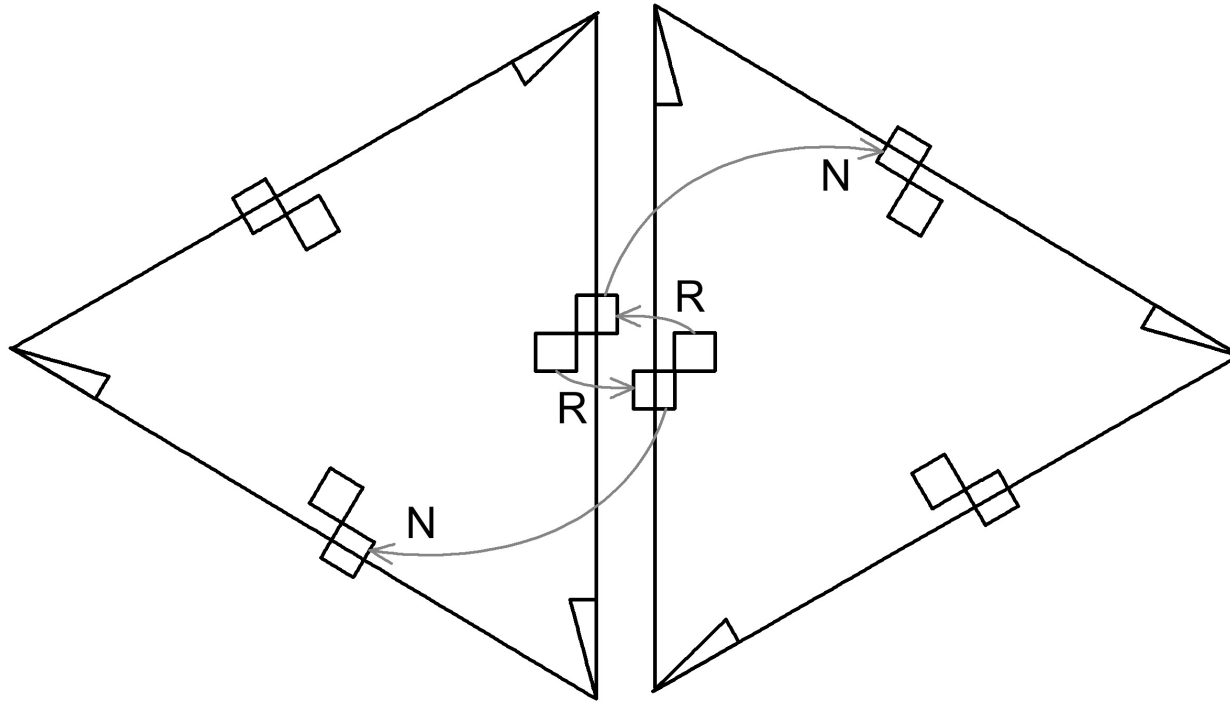

Connect Adjacent Faces

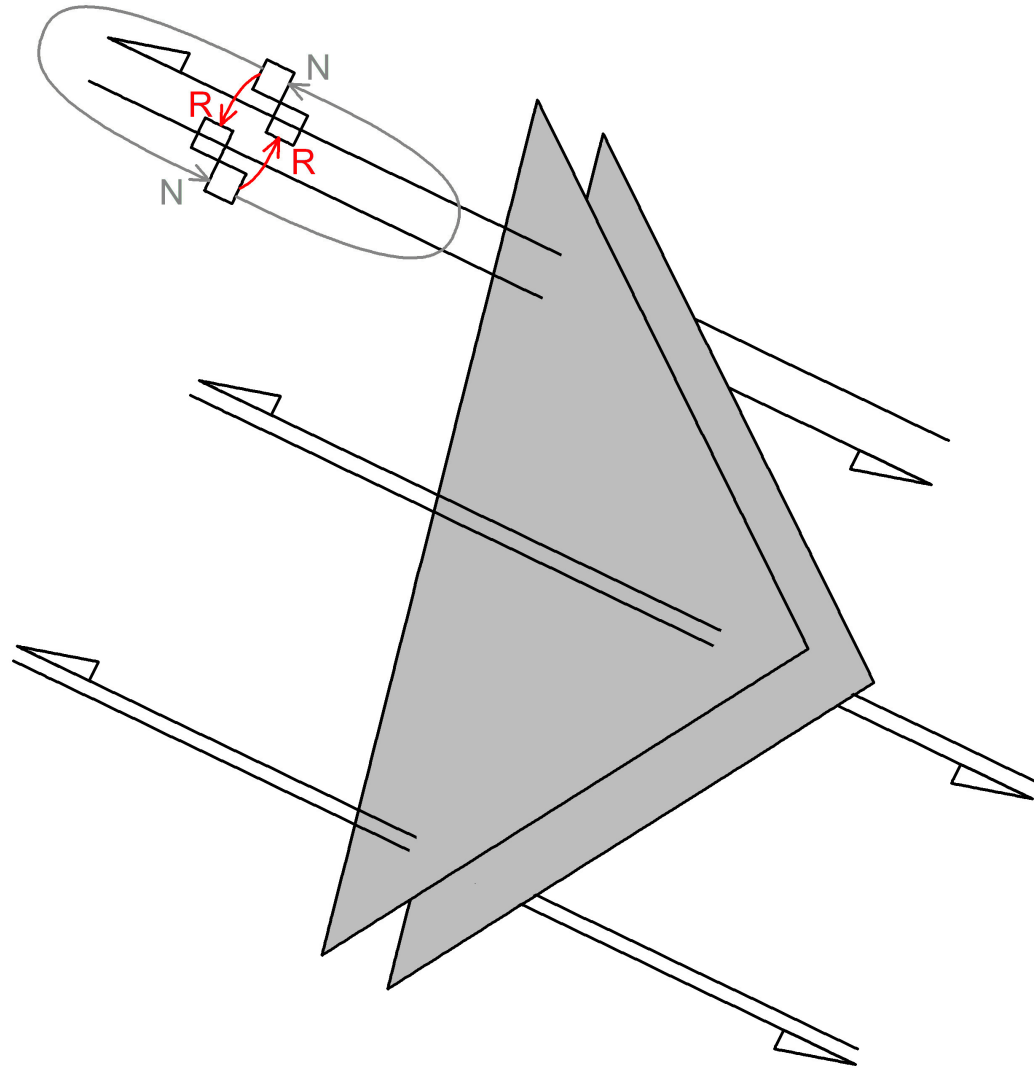

Flip23 – Disconnect Cells

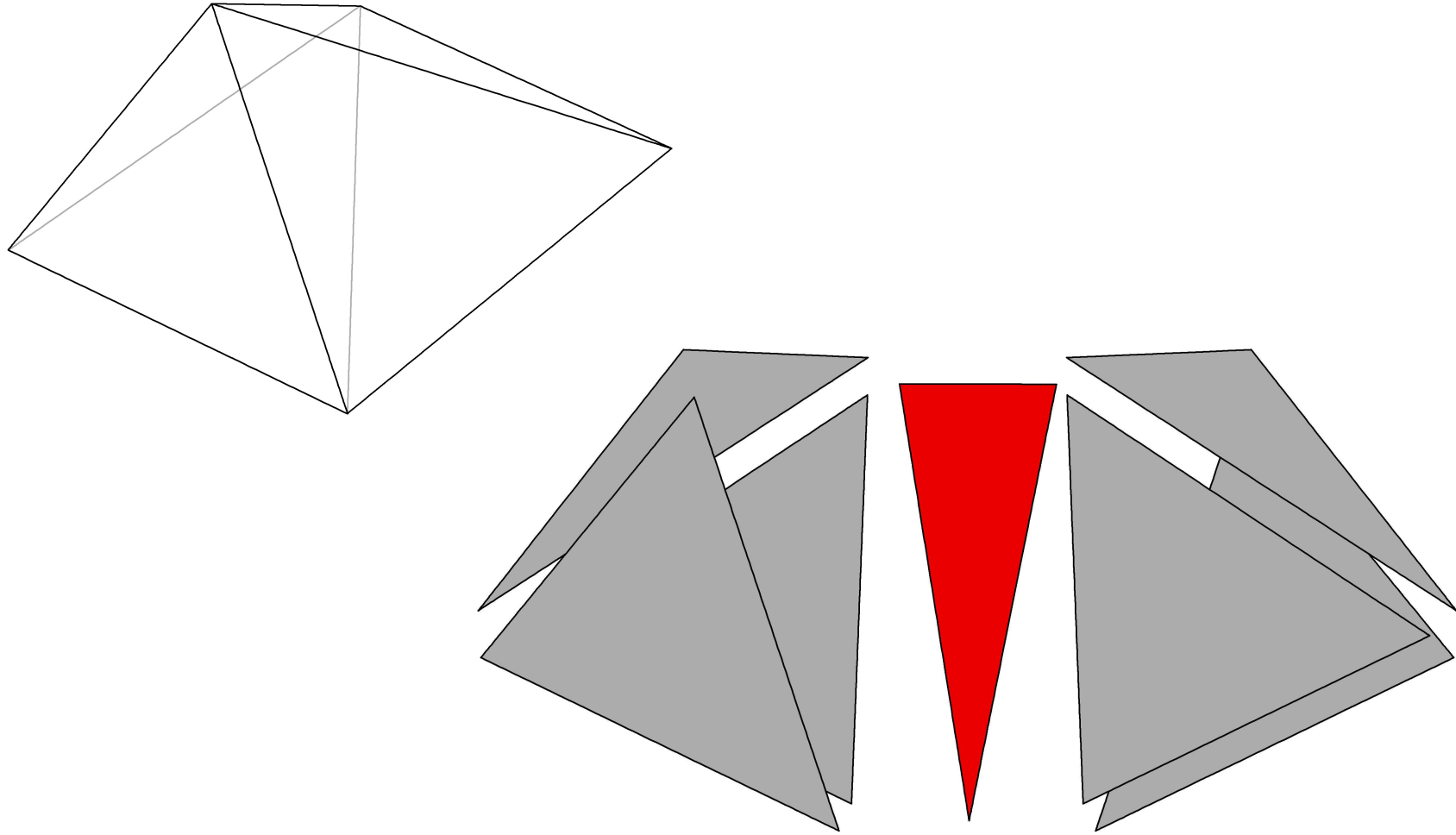

Flip23 – Connect Cells

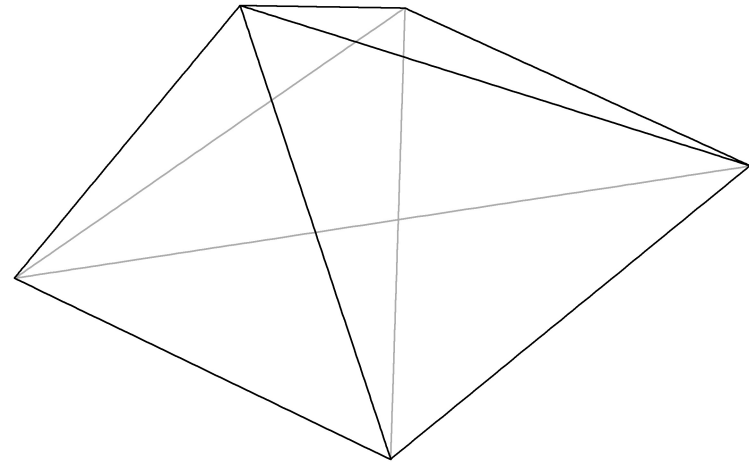
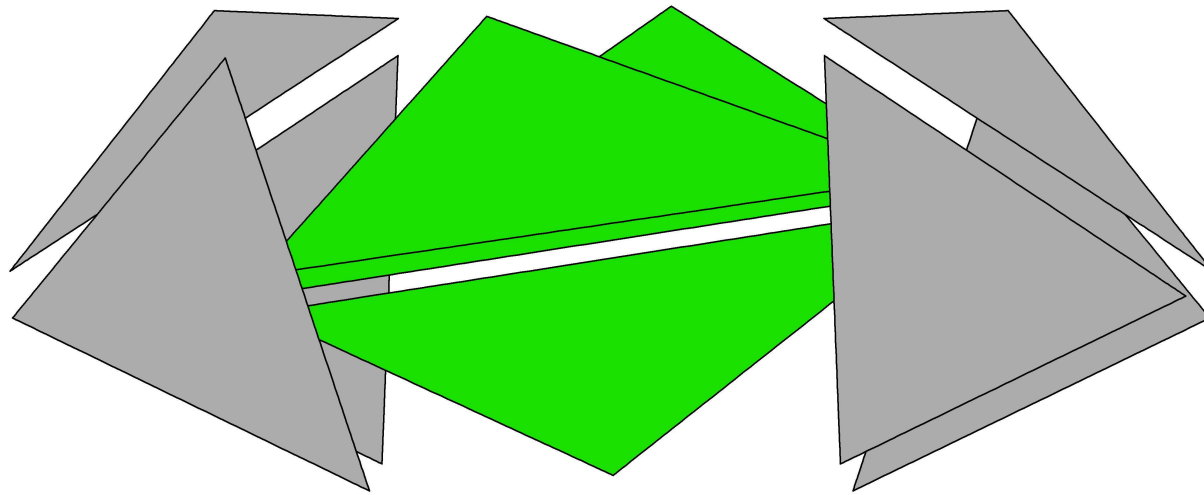

Layer Model

Level 5: insertDelPoint

Level 4: flip14, flip23, flip32, makeOriginTetrahedron

Level 3: connectFacesIntoTetrahedron,
disconnectTetraIntoFaces

Level 2: makeFace, connectAdjacentFaces,
connectNeighbourFaces, disconnectNeighbourFaces

Level 1: makeHalfAQE, connectHalfAQE, spliceHalfAQE,
splice, changeVertex

Level 0: AQE

Properties and Conclusions

- Associated HalfEdges in a primary and dual space are linked together permanently (Through pointer doesn't need to be changed)
- In a face approach, adjacent faces (from two adjacent cells) connected once are never disconnected. If there is need to remove face – two faces are removed simultaneously.
- It is possible to use an edge approach to build cells in our model. Both techniques can be mixed.
- We have a preliminary data structure for primal/dual navigation and construction