

A "DOOR-TO-DOOR" PATH-FINDING APPROACH FOR INDOOR NAVIGATION

L. Liu^a, S. Zlatanova^{a,*}

^a GIS Technology, OTB Research Institute for the Built Environment, Delft University of Technology, Jaffalaan 9, 2628 BX Delft, The Netherlands - (L.liu-1, S.Zlatanova)@tudelft.nl

Commission IV, WG IV/8

KEY WORDS: Indoor navigation, door-to-door navigation, Path-finding, 2D floor plan, Semantic building model

ABSTRACT:

Indoor navigation is gaining an increasing interest among researchers in many domains. In many cases users need to orient quickly in complex environments, which is not always the target of current routing algorithms. The paper reviews current indoor path-finding approaches and discusses some of the limitations. In order to support a natural movement in buildings, typically for emergencies, we propose a new indoor path-finding approach, that is, the "door-to-door" approach. We present an algorithm, which is applied to 2D floor plan of buildings with complex indoor structure. The algorithm consists of two-level routing: one is to get coarse route between rooms, and the other one is applied to single rooms to acquire the detailed route. Ultimately, several instances are given to illustrate advantages and feasibility of the door-to-door approach. From the test results it is evident this algorithm runs well even on quite complex floor plans. The paper concludes with a discussion of future work, which is to extend the routing approach into 3D, i.e. considering the vertical direction, indoor obstacles and path-finding in 3D scenarios.

1. INTRODUCTION

Over recent years indoor navigation is widely discussed among Location-based service (LBS), augmented reality (AR) and city management domains (Kolodziej & Hjelm, 2006; Wagner & Schmalstieg, 2003; Kolbe et al., 2005; Zlatanova & Baharin, 2008). There are also some technologies outside geo-domain (e.g. Robot Navigation) that provide good references to indoor navigation (Berg et al., 1997; Thrun & Bücken, 1996). There is common ground between these contexts of indoor navigation, that is, the knowledge regarding the indoor environment, user locations, etc. Path-finding results are used to offer guidance to users/robots. The indoor navigation process could be generalized and partitioned into three phases: localisation, routing and tracking (to guarantee that people follow the predetermined routes) (Gillieron et al., 2004). Localisation and tracking significantly depend on indoor positioning techniques. The indoor routing (i.e. path-finding) is closely related to the geometric model of a building. Therefore, a very important phase in routing is the simplification of the building structure to support the routing algorithm. The building floor plans are usually approximated with networks, regular and irregular cell subdivisions, which are referred to as navigation models. Only the network models are of interest for the scope of this paper.

Although widely used, the network navigation models, which are derived from the geometry of buildings, commonly fail to represent "natural" movement of pedestrians. "Natural" movement is interpreted here as looking for the direct (always along with the shortest) way from current location to a target location. In complex environments people prefer to walk towards a door they see and thus across large corridors and rooms (Fig. 1).

Network models are derived from geometry, which represent the building in a given moment of time and do not consider the

current status of buildings (e.g. reconstruction of a floor). In order to reflect indoor changes (e.g. in emergency cases), it is appropriate to derive navigation route on the fly. This requires semantically rich models of buildings to be considered. Presently, semantics can be managed with certain type of 3D building models such as CityGML or BIM (e.g. IFC).

CityGML is an international Open Geospatial Consortium (OGC) standard for semantic 3D city models which provides a common information model for the representation of 3D urban objects. CityGML can represent urban terrain and 3D objects in five levels of detail (LOD). LOD4, which specifies architectural models (interior of buildings), is used for representation of indoor environments (e.g. rooms, stairs and furniture). LOD4 could provide semantically-rich, object-based indoor description of buildings. Kolbe et al. (2005) apply CityGML to various disaster management applications and demonstrate how the connectivity between rooms for pedestrian access can be extracted using the shared openings between rooms.

In this paper, we aim at a routing algorithm, which reflects a "natural" movement and allows searching for feasible exits in a single room. We intend to select required information (e.g. doors) to automatically derive navigation routes based on semantics of buildings. Besides, we acknowledge the significance to display routes in 3D scenarios.

Following this introduction, section 2 discusses some limitations of current indoor network-based path-finding approaches. Section 3 presents the new "door-to-door" solution for indoor navigation routing. Section 4 explains the initial algorithm of this approach, which includes two-level searching: on the "floor" level and on the "single room" level. It is demonstrated on 2D floor plans. Section 5 provides several examples to illustrate advantages of the door-to-door routing.

* Corresponding author.

Section 6 concludes this paper and discusses future work, especially in 3D scenarios.

2. LIMITATIONS OF CURRENT INDOOR NETWORK-BASED NAVIGATION ROUTING

At present, geometry models of buildings are widely used for creating networks for indoor routing (e.g. Meijers et al., 2005; Boguslawski & Gold, 2009). Based on the geometry of a building, a topological structure could be conveniently derived to facilitate routing computation. Typical representatives are the approaches based on the traditional Dual Graph (DG) (Whitney, 1932). Lee (2001a) proposes the Node-Relation structure (NRS) to represent the connectivity of buildings based on Poincaré Duality theory (Munkres, 1984; Corbett, 1985). In order to represent indoor environments more accurate, Lee (2004) extended the NRS to Geometric Network Model (GNM), which introduced geometrical metric. Lee (2004) has also mentioned a skeleton-abstraction algorithm to help constructing 3D GNM, which is named Straight-Medial Axis Transformation (S-MAT) modelling method (Eppstein & Erickson, 1999; Choi & Lee, 2009). S-MAT can abstract linear features from simple polygons (such as corridors). Generally, DG model concentrates on the geometry of buildings and does not consider semantics or pedestrian-dependent factors (e.g. could not reflect if a door is only opened for pedestrians who have the key). Furthermore, S-MAT may have problems in complicated irregular indoor structures.

S-MAT follows the structure of the building and can not provide door-to-door routes for people. As shown in Fig. 1, the straight medial axis of a corridor is D1-M1-M2-M3-M4-D4. If a person needs to go to D2, the route will be D1-M1-D2. Door-to-door result is D1-D2. Even if the person could not see a door, e.g. D3 from D1, the door-to-door route will be D1-S1-D3 (the dash line), which means the person will see D3 until he reaches S1. Yet the DG route would be D1-M1-M2-M3-D3 in this case.

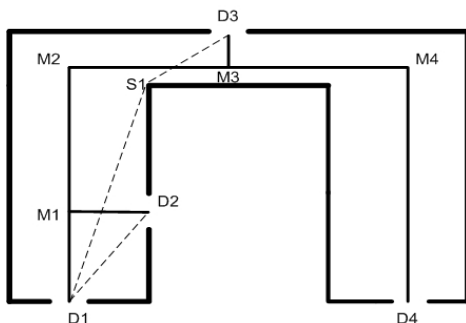

Figure 1. Comparison of DG and door-to-door route

Another approach is proposed by Lorenz et al. (2006). The indoor space (2D plan) is decomposed into cells to simplify the complex spaces and facilitate the creation of the graph structure. In this approach, the doors are explicitly considered and the cell centres are connected with doors. However, because of its cell-door-based representation, the network could result in some unnecessary tortuous paths. Similar to S-MAT, it will be unnecessary to pass through a cell centre (e.g. a node of the corridor), if a door is visible and can be directly approached. Besides, there is no completely automation of the cell decomposition.

Although existing network indoor routing methods can cope with indoor navigation on the basis of explicit topology of

buildings, it is still tricky for them to tackle complex buildings (e.g. irregular space shapes, inner rooms, etc.).

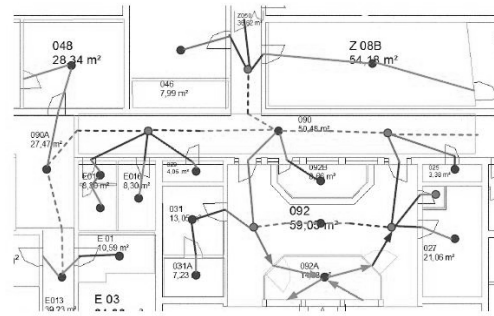

Figure 2. Cell centres and paths overlaid with a floor Plan (Lorenz et al., 2006)

Recently, the Multilayered Space-Event Model (MLSEM) is proposed, which attempts to provide a fundamental framework for indoor navigation (Nagel et al., 2010). It provides a multi-graph structure (Multi-layered Graph), which encompasses topological relationships between 3D spatial objects and coverage of sensors. Although it has some similarities with the DG approach, the framework is more conceptual and does not relate directly to the physical representation of buildings. It allows all kind of spaces to be considered and approximated to the Multi-layered Graph. For example, in our door-to-door approach, the door can be regarded as a space and the resulting dual graph will contain nodes representing doors only.

Theoretically, MLSEM has the potential to represent connectivity modelling of any type of indoor volumes. Until now, we have discussed three types of space-graph approximations: room-based, cell-door-based and door-based. Despite their various representations, these types of DG can still be embedded in the framework of MLSEM.

As mentioned previously, one of the major goals of door-to-door approach is to provide routing that adapts better to the walking behaviour of pedestrians. Furthermore, our approach aims to:

- Resolve navigation in complex shaped buildings
- Consider changes of indoor environments
- Allow dynamic re-computation of a route
- Automate route derivation from 3D semantic-geometric models of complex buildings

A detailed discussion on these issues could be found in Liu & Zlatanova, 2011.

3. "DOOR-TO-DOOR" APPROACH

As mentioned above, door-to-door is interpreted as the direct walking way from a door to the next visible door or the shortest possible way between two invisible doors. Nevertheless, it does not mean people have to strictly follow this way. The way merely provides potentially efficient routes for indoor navigation. In the following parts of this section, the corresponding algorithm will be introduced.

The algorithm is based on the following assumptions:

- A semantic-geometric model of the buildings is known. Semantics of buildings is pivotal to automation of route generation. Since it provides the

location, the type and the status (e.g. exit and locked) of doors

- The model provides (directly or indirectly) connectivity information as well as containment information (such as ‘the door is a part of a room’)
- The model contains information about all interior objects, which can become obstacles at certain moment
- The dynamic changes in the interior and the structure of the building are also known.

The algorithm presented below is a typical network-based algorithm. However, in our approach the doors (or openings) are approximated with nodes and the rooms with edges. This is in contrast to most currently available network models that treat doors (or openings) as edges connecting rooms (nodes). As shown in Fig. 1, door-to-door approach generates a shorter route compared to S-MAT (derived from the room-to-room connectivity).

At current stage, the routing strategy is organized as a two-level approach:

- Coarse: it is based on room-to-room connectivity on the floor level to determine the direction of movement.
- Refined: it is used in a single closed space to avoid all kind of obstructions and make people transfer in a door-to-door way.

For a certain person, firstly his/her location should be investigated and the final exit should be specified. Based on this information a route described as “passing which rooms” is generated according to certain path-finding algorithm. When the pedestrian reaches a room, a detailed calculation of the route in the room is carried out complying with door-to-door principle.

This strategy brings two advantages: 1) not all details should be extracted from the building model at once and 2) if some changes occur at indoor environments in emergencies, we could adjust the calculated route on the macro-level (i.e. to pass which rooms in a floor) at first. Another merit of this approach is that there is no space sub-dividing process (compared with cell decomposition for example).

4. COARSE AND FINE ALGORITHMS

It is assumed that the semantic building model is already obtained, and the required semantic information (doors, windows, etc.) has been extracted from the model. Please note in these initial developments interior obstacles (e.g. furniture, pillars, pedestrians, etc.) are not taken into account.

In the following sub-sections, the algorithm will be presented and discussed in detail: on the coarse level (between rooms in a floor) in section 4.1 and on the fine level (within a single room) in section 4.2.

4.1 Routing between Rooms

At this stage, the answer to “how to move from space to space in one floor” will be given. Here we are interested in rooms or corridors, where people can walk through. Based on semantics and geometry of a single building, the connectivity can be defined. For each room the number of door spaces attached to it and the other rooms these doors lead to could be clarified. Then

a traditional DG, whose nodes represent rooms and edges denote the connectivity with other rooms, can be constructed.

Firstly, the start room and the target room (or target door in case of evacuation) are specified. Secondly, a certain optimal routing algorithm (e.g. shortest, fastest or safest) is used to determine which rooms pedestrians will traverse in current circumstance. In our case we have used the *Dijkstra* algorithm (Dijkstra, 1959). Cost could be distance or travel time (in normal situations) between rooms or safety coefficient (in emergencies). Finally, if accidents occur in halfway (the target room is changed or the current room can not be passed by), then re-calculation of the route is implemented. In such cases, probably it is necessary to re-assign start/target room and re-compute the traversing sequence of rooms.

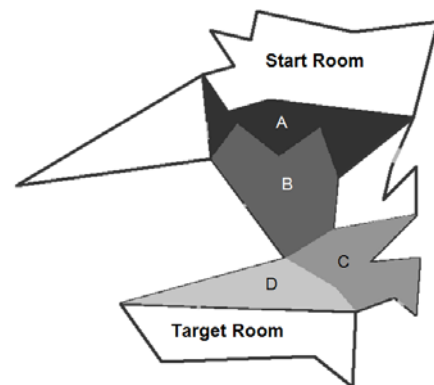

Figure 3. The room-to-room route selection on a “floor” level

Fig. 3 illustrates a routing example. The start room and the target room are indicated in Fig. 3. The sequence of rooms being traversed is A-B-C-D.

4.2 Routing within a Single Room

After specifying the route on the “floor” level and it is known which rooms should be accessed, the routing in a room can start. When a pedestrian arrive at the door attached to the next room, the navigation route is computed and provided. There are several steps to acquire the route:

Step 1: determine the start door and the target door in this room. After that, detect visibility between them. If there are multiple doors to the next room, take the closest one.

Step 2: if the two doors are mutually visible, then go to the next room; if it is not, go to step3;

Step 3: find out the concave points of the room (a polygon in a 2D floor plan);

Step 4: construct a graph with the node set consisting of start door, target door and all concave points of this room. Create adjacency matrix of the graph;

Step 5: for each node, determine other nodes visible from it and compute their distances with the node as weights in the adjacency matrix.

Step 6: use a shortest path algorithm to find out the shortest path between the start and target doors.

The pseudo-code of routing in a single room is given as following:

```
// “PtSet” is a node set consisting of start, target and all concave
// points. “visibleCp” is a vector storing the concave points
// visible from current point. “AdjMatrix” is the adjacency
```

```
// matrix of nodes in PtSet. "route" vector outputs the sequence
// number on the shortest path.
```

```
if (IsNotVisible(startDoor, targetDoor))
{
    Determine PtSet;
    Create AdjMatrix;

    For each node i in PtSet
    {
        visibleCp.clear();
        currentPt = PtSet[i];
        FindVisibleCP(currentPt, visibleCp);

        For each visible concave point j
            Corresponding weight in AdjMatrix =
                Distance (currentPt, visibleCp[j]);
    }

    DijkstraShortestPath (AdjMatrix, route);
}
```

Currently, we use the *Dijkstra* shortest algorithm to seek for the shortest journey. As it can be realised, the basic assumption is that a potential shortest path in a room (a polygon) consists of start door, target door and several concave corners. It is obvious that if a room is convex, then any two doors within the space are mutually visible. In other words, people can head to the target door directly in a convex shaped room. One thing that must be stressed is that interior obstacles (e.g. furniture, pillars, other pedestrians, etc.) in single rooms are not discussed in this paper.

After these steps, the door-to-door path in a single room is obtained. The pedestrian approaches the next room according to the sequence of rooms defined at the first level. The old target door becomes a start door, a new target door is identified and the algorithm is run again from Step 1. This approach is to be followed until reaching the target room on the floor.

Fig. 4 illustrates the shortest route from Door 1 to Door 2 in a concave room. Two concave corners are adopted as intermediate points on the route.

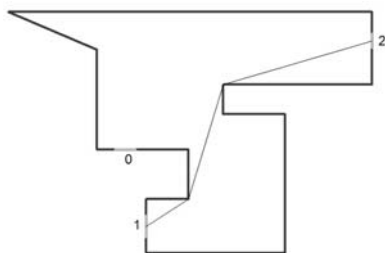

Figure 4. The shortest route in a concave room

5. CASE STUDY

In this section, two imaginary irregular polygons are used to illustrate the merits of the door-to-door method. Besides, a floor plan is also utilized to demonstrate feasibility of this approach.

5.1 Test on Irregular Polygons

Fig. 5 shows a weird shaped room (polygon), which is seldom seen in reality. Because it encompasses a number of concave points, it is favourable for verifying our algorithm. The black

dot in Fig. 5 represents the centroid of the room. The shortest route between Door 0 and Door 2 is also depicted. It is apparent that the route derived from our algorithm avoids detours. The algorithm does not adopt the room centre for path-finding inside one room. Therefore, compared with the S-MAT algorithm and the network derived from the Cell Decomposition method (Lorenz et al., 2006), the door-to-door route is more straightforward.

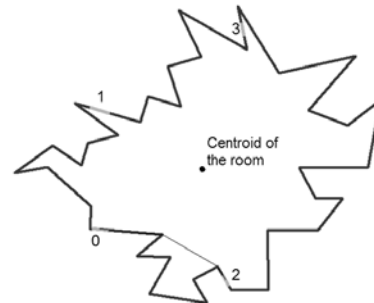

Figure 5. The shortest route in a room with strange shape

Another case is shown in Fig. 6. In this example, the centroid of the room is outside the polygon. Traditional DG method might have problem to cope with this case. Yet with the door-to-door approach, the navigation route from Door 0 to Door 1 in the single room still can be derived.

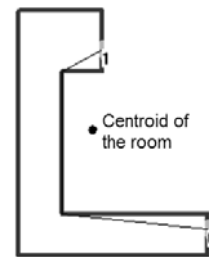

Figure 6. The case that the centroid is outside of the room

5.2 Test with the floor plan of Vermeer Toren, Delft, the Netherlands

The floor plan used here is provided by a high-rise building at Delft named “Vermeer Toren”. This building is selected for the test because its 3D model is also available and will be used in the future for emergency simulations. The plan offers explicit semantics. Each independent space is regarded as a “Room” (Fig. 7 (a)). The Openings attached to every Room are also known. Thus, from the information of Openings we obtain the connectivity between different Rooms. A room-to-room DG was constructed based on connectivity of the floor plan and the path-finding is implemented on “floor” level. After the coarse route is acquired, the detailed door-to-door routes in each room are also computed. The final result is demonstrated in Fig. 7 (b) and (c).

Fig. 7 (b) indicates the coarse route. It is derived from the DG of the 2D plan. A is the start room and room B is the destination. It is clear that a pedestrian will arrive at the target room after traversing several rooms. The traversing sequence is A-M₁-M₂-B.

In Fig. 7 (c), the start and target rooms are same to Fig. 7 (b). The lines attached to rooms denote the locations of doors. The entire door-to-door route between the two locations (A & B) is

depicted by a chain. It should be noted that the route is distinct from routes derived from the network based on traditional DG. It employs the concave corners within single rooms as “landmarks” to transfer. The door-to-door approach has no need of skeleton-abstraction (e.g. S-MAT).



(a)



(b)

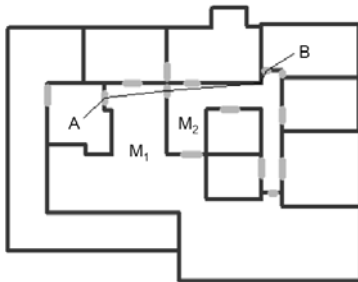

(c)

Figure 7. (a) The floor plan with semantics; (b) the coarse route on the “floor” level; (c) the entire route between two specific locations on the floor plan

Please note that if the shape of the rooms is complex or there are internal rooms, it may appear that the routes between two specific rooms might differ when the start and target are swapped. This is very well illustrated in our example. When the start room (Room A in Fig. 8) becomes the target room, the entire route is changed (Fig. 9):

There are three doors to connect rooms M_1 and M_2 , which are d_2 , d_4 and d_5 respectively. As shown in Fig. 8, if a person departs from A and then reaches d_1 (into room M_1), he will make a choice among these three doors to access room M_2 . Then d_2 is selected because it is the closest and visible door to d_1 . After entering room M_2 , he keeps looking for the next suitable door in this room to access room B. Finally, the door d_3 , the only door linking M_2 to B, is selected. Likewise, when the person heads to room A from B (Fig. 9), d_4 is the closest and visible door to d_3 . Consequently, the person will pass by d_4 to get into room M_1 , and find the d_1 to room A after transiting several concave corners.

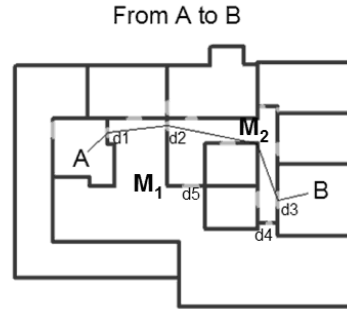

Figure 8. The route from room A to room B

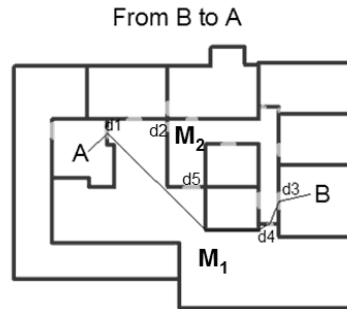

Figure 9. The route from room B to room A

For a pedestrian, the next step he will take substantially depends on his entering location to the room. Accordingly, it is reasonable to acquire different routes between two rooms when the start room and target room are reversed. Firstly, it means people don't need to follow the same route in the context of evacuation. Secondly, this feature complies with the concept of “natural” movement. That is, pedestrians always are inclined to select available and the closest doors (openings) to escape. Also on account of this feature, we avoid using the term “shortest” for an entire door-to-door route. It is worth noting that we only adopt the term in the context of single rooms and considering the direction of movement.

6. CONCLUSION AND FUTURE WORK

In this paper we have presented a new approach for indoor navigation, which is based on a two-level routing strategy. The coarse level utilises the traditional DG approach for room-to-room navigation and the fine level is a new door-to-door algorithm. The door-to-door algorithm is tested with a variety of complex spaces, some of which are presented in this paper. The entire routing approach is also tested for a few real building floors. The results show several merits of the door-to-door algorithm. It can serve complex floor plans and provide the door-to-door route in any kind of (concave) spaces with arbitrary number of doors between two neighbouring spaces.

As mentioned previously, the routing using this algorithm is still at very early stage. The algorithm is merely applied to one floor. In other words, it does not consider the vertical connection between floors (e.g. staircases, elevators). Moreover, the classification of doors (e.g. status to denote door is open or locked) is not considered yet.

In the next steps, we will consider several enhancements and adaptation. We will attempt to implement the coarse level routing with door-to-door DG rather than traditional DG. Furthermore, door-to-door algorithm will be extended to

consider indoor obstacles. There are several types of obstacle: moveable, fixed or dynamic obstacles. A moveable obstacle could be a desk or book cabinet in an office; a fixed one could be pillars in a corridor. Dynamic obstacles could be crowd flows or extending hazards (e.g. fire, smoke) in a building. Ranges of all these obstacles can be represented as 2D geometry in a floor plan. Then the algorithm should be improved to incorporate the influence of all kinds of obstacles on indoor path-finding. For instance, several obstacles with tight gaps can be regarded as one larger obstacle and can be approximated with one polygon. The vertexes of this polygon can be taken into account to generate the door-to-door route between two indoor locations.

After tackling the indoor navigation routing based on 2D floor plans, the next step will be employment of CityGML LOD4 to investigate the door-to-door indoor path-finding on 3D scenarios. On the basis of the semantic-rich model, we could acquire door spaces and the connectivity relationships within a whole building. Yet the routing problem will become more complex because we need to determine the field of view (e.g. by a frustum) of a certain person in 3D space, when indoor routing is required. Moreover, 3D obstacles will also aggravate the difficulty. For instance, smoke pervasion makes smoke dynamically become irregular shaped 3D objects. So the complexity will be raised when avoiding smoke is considered. While no matter how complicated the indoor scenarios might be, the core concept is still to find out the shortest possible way between two mutually invisible doors (or exits) within single rooms.

REFERENCES

- Boguslawski, P. & Gold, C., 2009. Euler Operators and Navigation of Multi-shell Building Models. In: *Developments in 3D Geo-Information Sciences LNG&C*, Springer, Berlin, pp. 1-16.
- Choi, J. & Lee, J., 2009. *3D Geo-Information Sciences*. Springer, Berlin, pp. 283-299.
- Corbett, J. P., 1985. A general topological model for spatial reference. In: *Report of Spatially Oriented Referencing Systems Association (SORSA) Workshop*, pp. 9-24.
- Dijkstra, E. W., 1959. A note on two problems in connexion with graphs. *Numerische mathematik*, 1, pp. 269-271.
- Eppstein, D. & Erickson, J., 1999. Raising Roofs, Crashing Cycles & Playing Pool: Applications of a Data Structure for Finding Pairwise Interactions. In: *14th Annual ACM Symposium on Computational Geometry*, Minneapolis, USA, pp. 58-67.
- Gillieron, P.-Y., Büchel, D., Spassov, I. & Merminod, B., 2004. Indoor Navigation Performance Analysis. In: *Proceedings of the 8th European Navigation Conference GNSS 2004*, Rotterdam, The Netherlands.
- Gröger, G. & Plümer, L., 2005. CityGML – Interoperable Access to 3D City Models. In: *Proceedings of the Int. Symposium on Geo-information for Disaster Management*, Delft, The Netherlands, pp. 883-898.
- Kolodziej, K. & Hjelm, J., 2006. *Local Positioning Systems: LBS application and services*. Taylor & Francis, Boca Raton, USA, pp.165-224.
- Lee, J., 2001a. 3D Data Model for Representing Topological Relations of Urban Features. In: *Proceedings of the 21st Annual ESRI International User Conference*, San Diego, USA.
- Lee, J., 2001b. A spatial access oriented implementation of a topological data model for 3D urban entities. In: *University Consortium for Geographic Information Science (UCGIS) Summer Assembly*, Buffalo, New York.
- Lee, J., 2004. A Spatial Access-Oriented Implementation of a 3-D GIS Topological Data Model for Urban Entities. *Geoinformatica*, 8(3), pp. 237-264.
- Liu, L. & Zlatanova, S., 2011. Towards a 3D Network Model for Indoor Navigation. In: *Proceedings of the 28th Urban Data Management symposium*, Delft, The Netherlands, Sept. 28-30, 2011 (accepted).
- Lorenz, B., Ohlbach, H. J., & Stoffel, E. P., 2006. A Hybrid Spatial Model for Representing Indoor Environments. In: *Proceedings of W2GIS (LNCS 4295)*, Hong Kong, China, pp. 102-112..
- Berg, M. D., Kreveld, M. V., Overmars, M. & Schwarzkopf, O., 1997. *Computational Geometry*. Springer-Verlag, Berlin, pp. 265-288.
- Meijers, M., Zlatanova, S. & Preifer, N., 2005. 3D geoinformation indoors: structuring for evacuation. In: *Proceedings of Next generation 3D city models*, Bonn, Germany.
- Munkres, J. R., 1984. *Elements of Algebraic Topology*. Addison-Wesley, Menlo Park.
- Nagel, C., Becker, T., Kaden, R., Li, K., Lee, J. & Kolbe, T. H., 2010. Requirements and Space-Event Modeling for Indoor Navigation. OpenGIS® Discussion Paper OGC 10-191r1, Open Geospatial Consortium.
- Open Geospatial Consortium, 2008. OpenGIS City Geography Markup Language (CityGML) Encoding Standard v1.0.0, Open GIS Consortium. <http://www.opengeospatial.org/standards/citygml> (accessed 01 April 2011)
- Thrun, S., Bücken, A., 1996. Integrating grid-based and topological maps for mobile robot navigation. In: *Proceedings of the AAAI Thirteenth National Conference on Artificial Intelligence*, Portland, Oregon, pp. 944-950.
- Pu, S. & Zlatanova, S., 2005. *Geo-information for disaster management*. Springer Verlag, Berlin, pp. 1143-1161.
- Wagner, D., Schmalstieg, D., 2003. First steps towards handheld augmented reality. In: *Proceedings of the 7th International Symposium on Wearable Computers (ISWC 2003)*, White Plains, NY, USA, pp. 127-137.
- Whitney, H., 1932. Non-separable and planar graphs. *Transactions of the American Mathematical Society*, 34, pp. 339-362.
- Zlatanova, S. & Baharin, S., 2008. Optimal Navigation for First Responders. In: *Information systems for crisis response and management*, Harbin, China, pp. 529-542.